

REV.	DESCRIPTION	CHK	DATE

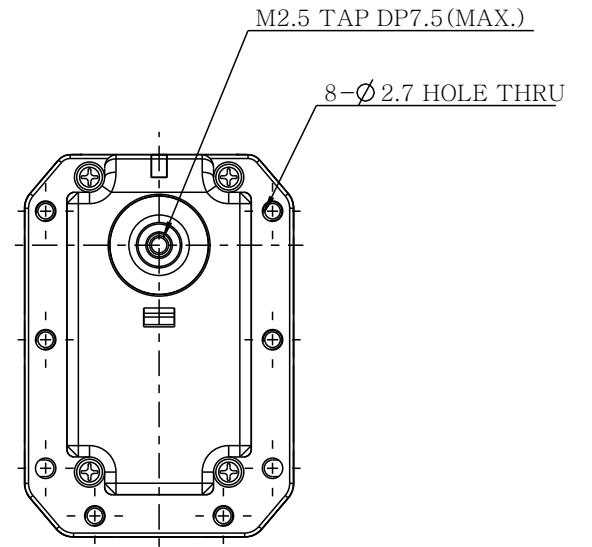
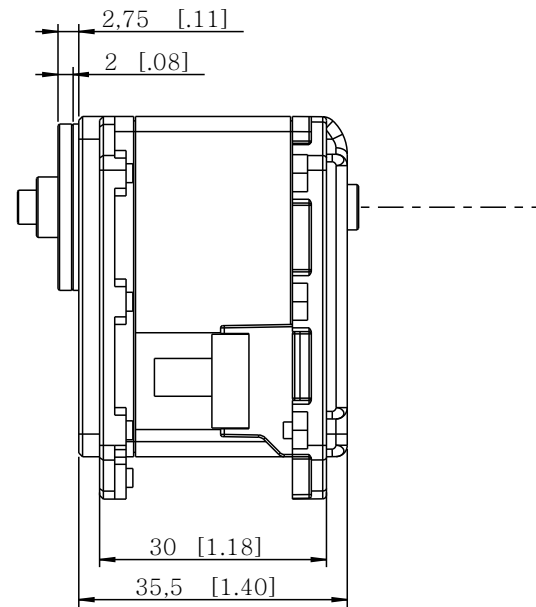
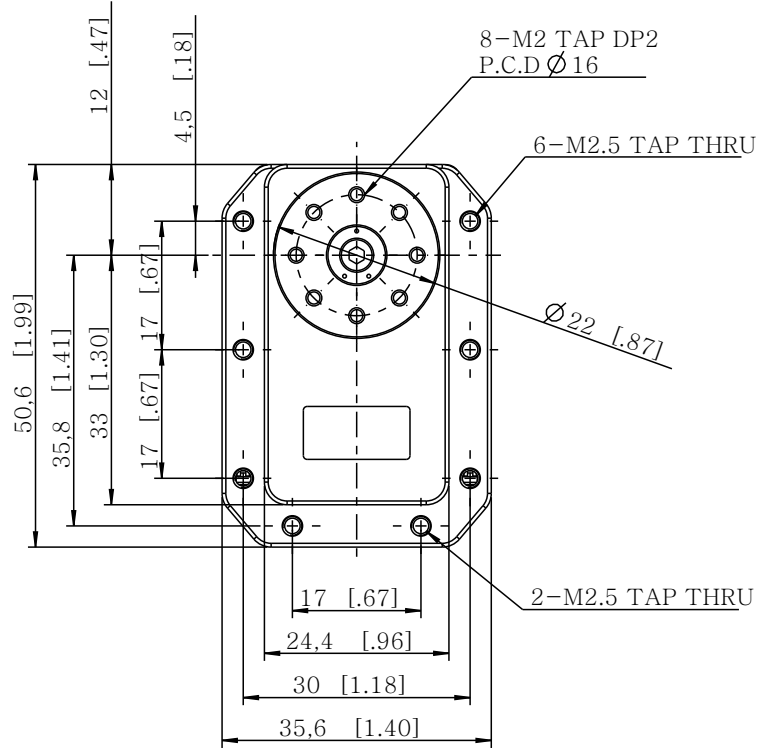
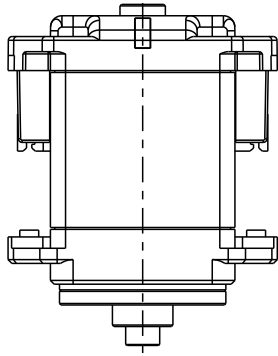

[FOR REFERENCE ONLY]

MX-28A	Material	Scale	Unit	Sheet	ROBOTS
10/05/2016		Nonescale	mm	1 of 3	A4